

# FL SMALL



## FEATURES

### MODULAR GENERAL-PURPOSE LED FLOOD & AREA LIGHTING LUMINAIRE.

The FL series LED luminaire provides a energy efficient, high performance solution to many low light level applications across your sporting complex. The FL was designed to provide a common family of products that can be used for sporting field, parking lots, accent lighting and security lighting throughout your complex to simplify design. Available in wattages from 80-320W and in both area lighting and flood lighting distributions.

- » Standard 0-10V dimming
- » Standard 10kv, 10ka surge protection
- » Modular design for ease of service
- » Various mounting options including slip fit, trunion mount, pole mount and ceiling mount
- » 125+ Lumens per watt
- » 3G vibration rated



## ORDERING GUIDE

EX: FL-B-40-C-T2M-70-BK-00-BS

PRODUCT	INPUT VOLTAGE	WATTAGE	MOUNTING	OPTIC	CCT	HOUSING COLOR	LIGHTING CONTROLS	ACCESSORY
FL					70			
<b>FL</b> FL SERIES	<b>B</b> 120V - 277V <b>C</b> 347V - 480V	<b>40</b> 40 <b>80</b> 80 <b>120</b> 120 <b>160</b> 160 <b>200</b> 200 <b>240</b> 240 <b>280</b> 280 <b>320</b> 320	<b>C</b> TRUNION <b>D</b> SURFACE <b>L</b> SLIP FIT <b>T</b> POLE	<b>T2M</b> TYPE II MEDIUM <b>TSX1</b> TYPE V MEDIUM <b>T3M</b> TYPE III MEDIUM <b>T4M</b> TYPE IV MEDIUM <b>T5U</b> 10 DEGREE <b>T5V</b> 25 DEGREE <b>T5W</b> 40 DEGREE <b>T5S</b> 60 DEGREE <b>T5M</b> 90 DEGREE	<b>70</b> 70	<b>BK</b> BLACK <b>GR</b> GREY <b>BZ</b> BRONZE <b>WH</b> WHITE	<b>00</b> NONE <b>01/3</b> 3 PIN RECEPTACLE <b>01/5</b> 5 PIN RECEPTACLE <b>01/7</b> 7 PIN RECEPTACLE <b>02</b> MOTION SENSOR <b>05</b> 0-10V DIMMING	<b>BS</b> BIRD SPIKES <b>BL</b> BACK LIGHT SHIELD <b>2S</b> 20KV/10KA SPD <b>SC</b> SAFETY CABLE

# FL SMALL

MODULAR GENERAL-PURPOSE LED FLOOD AND AREA LIGHTING LUMINAIRE.



## DIMENSIONS

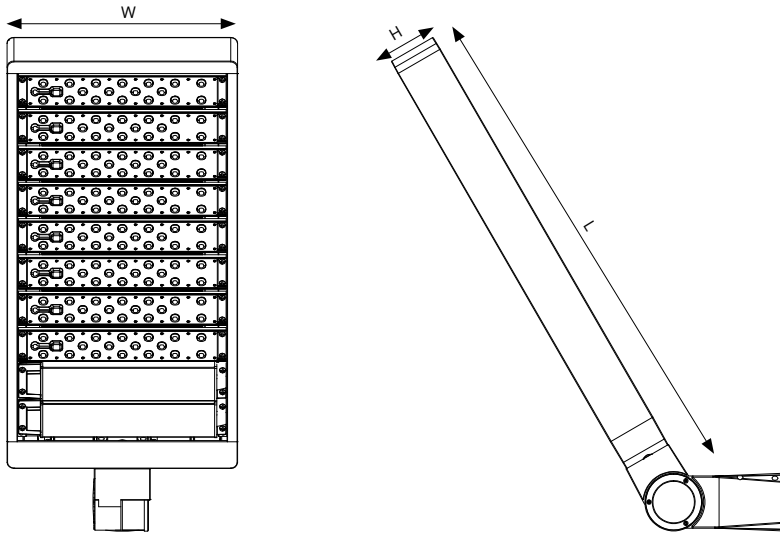

DIMENSIONS			
WATTAGE	W (IN.)	L (IN.)	H (IN.)
40	12.99	5.91	4.41
80	12.99	8.27	4.41
120	12.99	10.63	4.41
160	12.99	12.99	4.41
200	12.99	17.72	4.41
240	12.99	20.08	4.41
280	12.99	22.4	4.41
320	12.99	24.8	4.41

## SPECIFICATIONS

### GENERAL DESCRIPTION

The FL series is a high efficiency, compact and economical LED flood and area lighting luminaire. The complete luminaire is UL Listed to UL1598 with a maximum ambient operating temperature of 50C. The driver and LED housings are fabricated of heavy duty high cast aluminum. The complete luminaire assembly is IP66 rated, 3G vibration tested and is manufactured to an ISO 9001:2000 certified production facility.

### HOUSING

The housing is constructed of heavy duty die cast aluminum with a corrosion resistance polyester powder coat with a minimum salt spray rating of 1000 hours per ASTM B117 / ISO 9227:-2012. The entire luminaire has been tested to meet the requirements of an ANSI C136.31-2010,3G.

### ELECTRICAL SYSTEM

The drivers accepted the specified line voltage, to with +/- 10% without the aid of an integral step down transformer. The drivers include integral transient surge protection in accordance with IEEE C62.41 6kV/6kV. The LED drivers have a minimum power factor of 0.90 with a Total Harmonic Distortion no greater than 20%. Drivers come standard with 0-10V dimming leads. The system includes a secondary surge protection system with supplementary coverage in accordance with IEEE C62.41.C High (10kA and 10kV Standard, 20vK is optional). The drivers include standard 1-10V dimming input and can dim to 10% output.

### OPTIC ASSEMBLY

Each LED module is sealed by a dedicated polycarbonate optical panel that provides IP66 protection to the PCB. Each PCB utilized on board TVS (Transient Voltage Suppressors) for added protection of the LEDs. The LEDs generate the specified color temperature with a tolerance of no more than +/- 6.6% to ensure consistent color across the project. All CRI offerings are stated as a minimum, typical CRI will be higher or equal to the published minimum.

### WARRANTY

The entire product shall be covered by a minimum five (5) year limited fixture warranty. Longer term warranties are available, contact CHM for additional details.

## SUPPLEMENTARY

OUTPUT TABLE		
WATTAGE	CRI	APPROXIMATE LUMENS
40	70	5000
80	70	10000
120	70	15000
160	70	20000
200	70	25000
240	70	30000
280	70	35000
320	70	40000

CCT ADJUSTMENT FACTOR	
CCT	FACTOR
3000K	0.098
4000K	1.000
5000K	1.015
5700K	1.025

LOADING INFORMATION			
WATTAGE	EPA @ 0 DEGREES (SQ.FT)	EPA @ 90 DEGREES (SQ.FT)	WEIGHT (LBS)
40	0.5	0.64	11.3
80	0.5	0.9	13.8
120	0.5	1.15	15.9
160	0.5	1.41	18.2
200	0.65	1.92	21.5
240	0.73	2.17	24.4
280	0.85	2.43	27.5
320	0.91	2.68	30

## CANDELA PLOTS

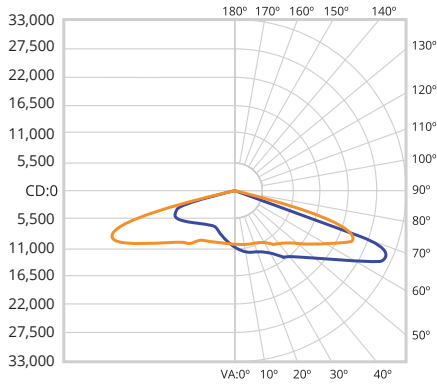

90° H  
MAX CD: 80° H

**T2M1**

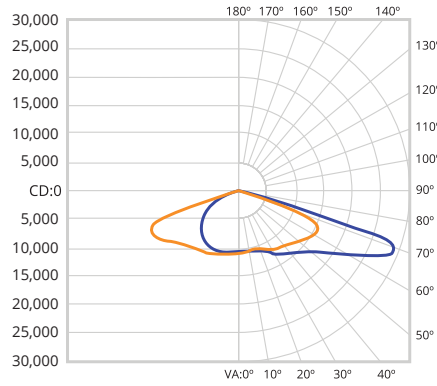

90° H  
MAX CD: 70° H

**T3M1**

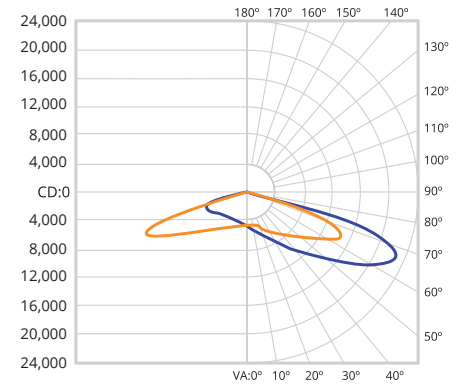

90° H  
MAX CD: 60° H

**T4M1**

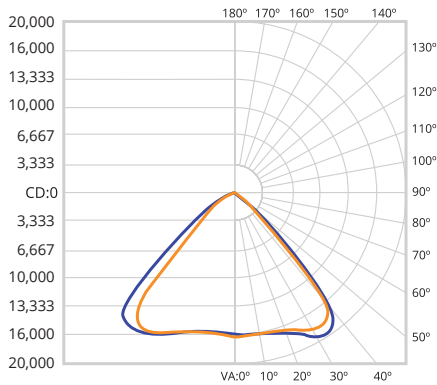

0° H  
MAX CD: 140° H

**T5M1**

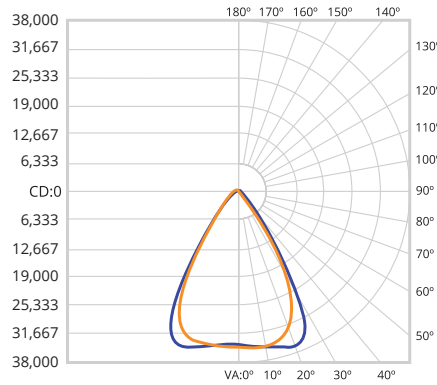

0° H  
MAX CD: 40° H

**T5S1**

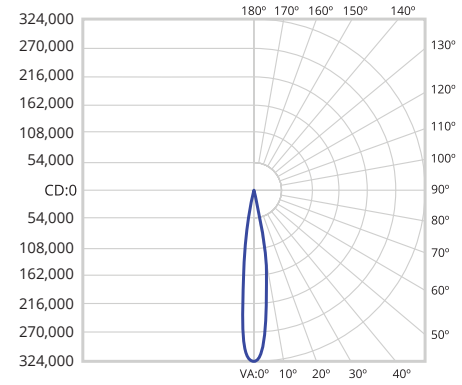

0° H  
MAX CD: 340° H

**T5U1**

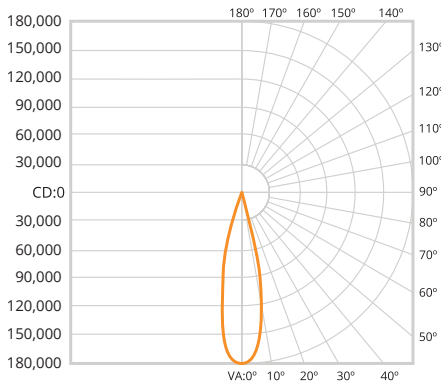

0° H

**T5V1**

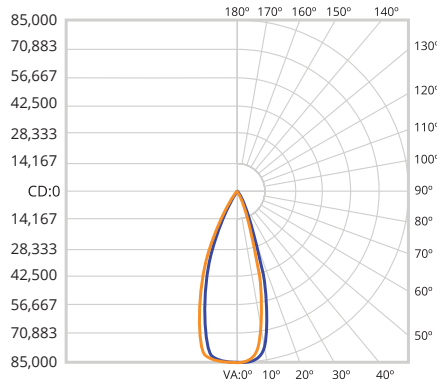

0° H  
MAX CD: 40° H

**T5W1**